



Carter Collection

Colours represented are to be used as a guide only.
Please refer to manufacturers swatch for a more accurate colour match.

Please note that colour shadings can vary slightly from each roll of fabric.
We cannot guarantee a precise match to these samples or between cut lengths and upholstered goods.

foamflex™
Award Winning Seating Technology

10/09/2019

CARTER COVER GUIDE - STANDARD BACK

Please use this guide when ordering the following pieces to clarify cover options.

STANDARD BACK

L2, P, CO, AU, R1 (LH2, FST, COR, ALU, RH1) Group

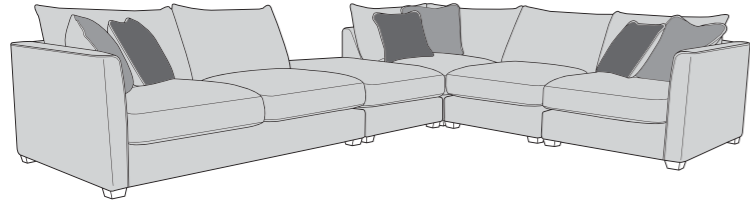

L1, AU, CO, P, R2 (LH1, ALU, COR, FST, RH2) Group

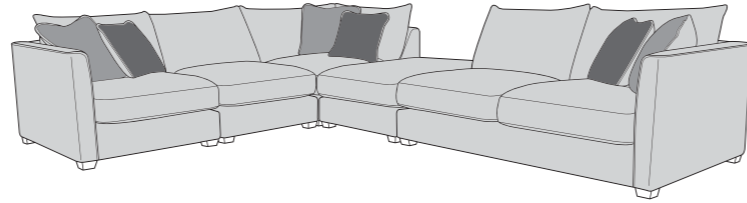

L2, CO, AU, R1 (LH2, COR, ALU, RH1) Group

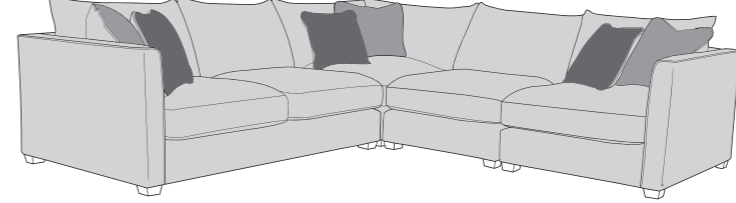

L1, AU, CO, R2 (LH1, ALU, COR, RH2) Group

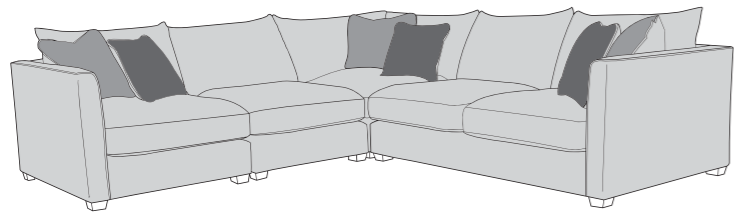

L2, CO, AU, P (LH2, COR, ALU, FST) Group

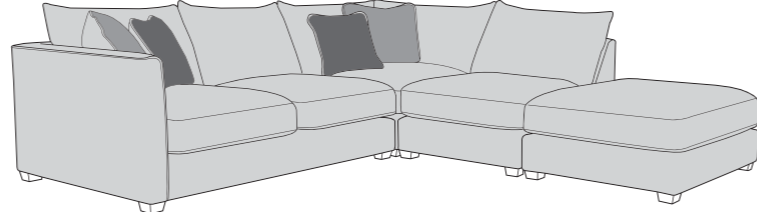

P, AU, CO, R2 (FST, ALU, COR, RH2) Group

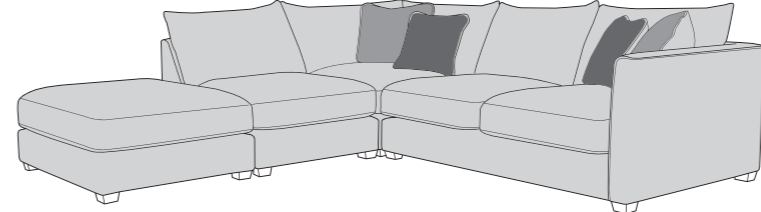

L2, CO, R2 (LH2, COR, RH2) Group

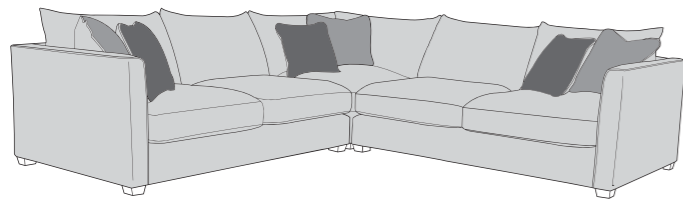

L2, CO, R1 (LH2, COR, RH1) Group

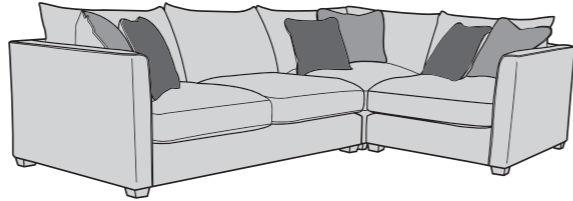

L1, CO, R2 (LH1, COR, RH2) Group

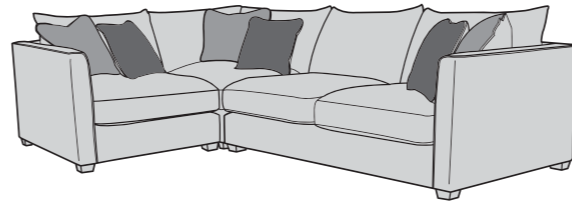

L1, CO, R1 (LH1, COR, RH1) Group

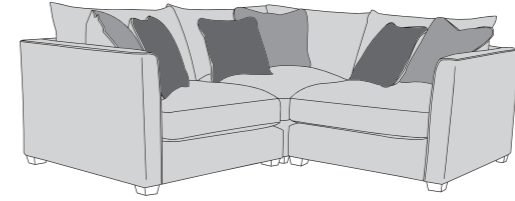

AU (ALU): Armless Unit

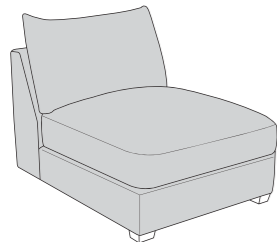

3 Seater Sofa (3ST)

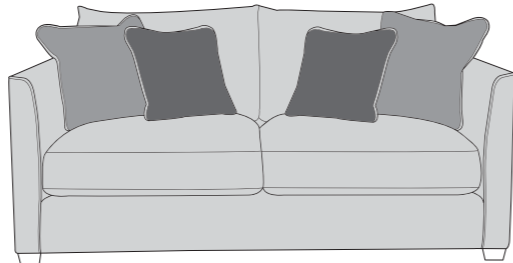

2 Seater Sofa (2ST)

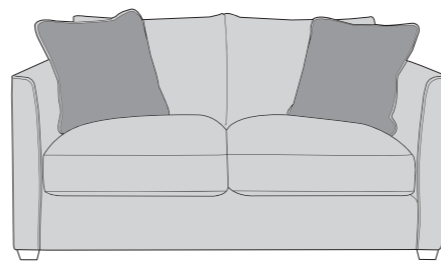

Arm Chair (1ST)

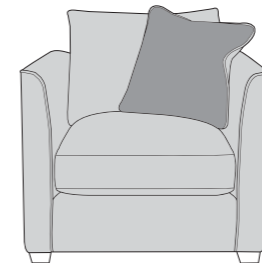

ACCENT PIECES

Carter (Salute) Swivel Chair (SWC)

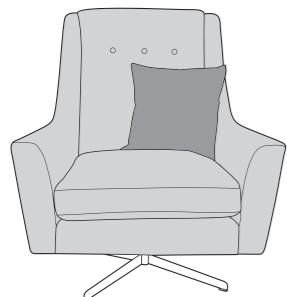

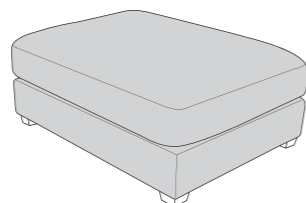

Large Footstool P (FST)

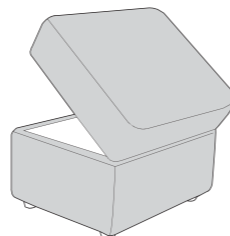

Storage Footstool F (FSS)



-  **COVER 1**
(BODY)
-  **COVER 2**
(LARGE SCATTER)
-  **COVER 3**
(SMALL SCATTER)

Large Scatter Cushions

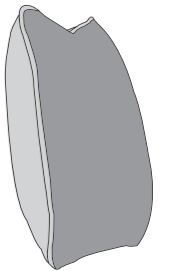

Front = Cover 2
Piping = Cover 1
Reverse = Cover 1

Small Scatter Cushions

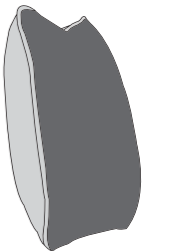

Front = Cover 3
Piping = Cover 1
Reverse = Cover 1

BFM British Furniture Manufacturers
REPRESENTING THE INDUSTRY

A©ID
ANTI COPYING IN DESIGN

CARTER DIMENSIONS (CM)

AVAILABLE PIECES	HEIGHT 1	OUTBACK HEIGHT	WIDTH 2	DEPTH 3	ARM HEIGHT	SEAT HEIGHT 4	SEAT DEPTH (STD) 5	SEAT WIDTH 6	ACCESS DIAGONAL 7	WEIGHT (KG)	SCATTER CUSHION NO.
L2, P, CO, AU, R1 GROUP or L1, AU, CO, P, R2 GROUP	86	67	374	258	67	47	66	N/A	N/A	167	3 Large, 3 Small
L2, CO, AU, R1 GROUP or L1, AU, CO, R2 GROUP	86	67	269	258	67	47	66	N/A	N/A	149	3 Large, 3 Small
L2, CO, AU, P GROUP or P, AU, CO, R2 GROUP	86	67	269	258	67	47	66	N/A	N/A	131	2 Large, 2 Small
L2, CO, R2 GROUP	86	67	269	269	67	47	66	N/A	N/A	140	3 Large, 3 Small
L2, CO, R1 GROUP or L1, CO, R2 GROUP	86	67	269	183	67	47	66	N/A	N/A	124	3 Large, 3 Small
L1, CO, R1 GROUP	86	67	183	183	67	47	66	N/A	N/A	108	3 Large, 3 Small
L2/R2 UNIT	86	67	164	105	67	47	66	155	194	52	1 Large, 1 Small
L1/R1 UNIT	86	67	78	105	67	47	66	78	136	36	1 Large, 1 Small
CO: CORNER UNIT	86	67	105	105	N/A	47	66	66	144	36	1 Large, 1 Small
AU: ARMLESS UNIT	86	67	75	105	N/A	47	66	75	129	25	N/A
ACCENT PIECES											
CARTER SWIVEL CHAIR	100	N/A	90	98	N/A	58	60	55	121	25.5	1
LARGE FOOTSTOOL (P)	47	N/A	78	105	N/A	N/A	N/A	N/A	128	18	N/A
STORAGE FOOTSTOOL (F)	45	N/A	63	50	N/A	N/A	N/A	N/A	75	12.5	N/A

* Hardwood & composite board frame.

* Dowelled, screwed, glued & stapled joinery.

* Light and Dark Wood foot options.

* Reversible fibre filled backs for added comfort.

* Feather filled scatter cushions included. 

* Optional extra fibre bolster available.

* Award winning foamflex seat interior with 5 year guarantee.

Each unit is fully upholstered, with hidden crocodile clips making them suitable for individual use.

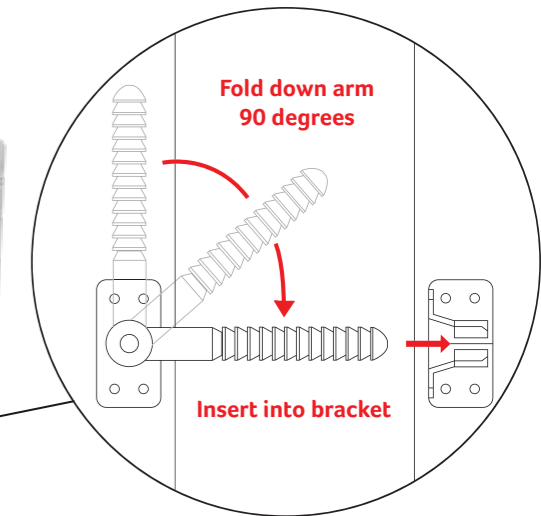

* Serpentine seat springs & silent wire.

* Elasticated back webbing.

DIMENSION GUIDE

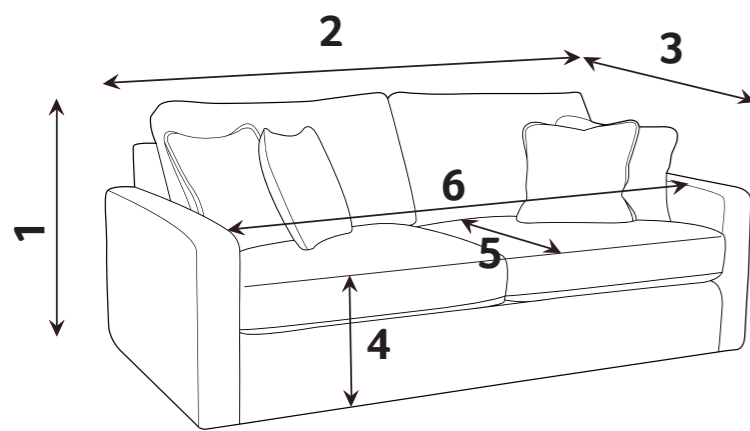

Check the diagonal access dimension to ensure furniture will fit in your home.

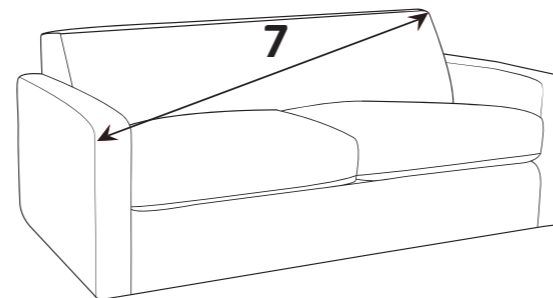

1 - HEIGHT
2 - WIDTH

3 - DEPTH
4 - SEAT HEIGHT

5 - SEAT DEPTH (STD & PILLOW)
6 - SEAT WIDTH

7 - DIAGONAL ACCESS

Illustrations used for reference only.

Please note: All dimensions are approximate. Allow tolerance of +/- 2.5cm.

foamflex™

Our new, expertly engineered foam seat interior gives you the comfort of fibre with the retention of foam. Our foamflex seat interiors have been granted the FIRA GOLD Award, a mark of quality under-pinning all necessary testing of the product materials, design and production techniques.

CARE GUIDE

To improve the longevity of your hand-made furniture, we recommend rotating cushions (where applicable). For further information on maintaining your furniture, please refer to the Care Guide located under the seat platform.



Our foamflex seat interiors have been granted the FIRA GOLD Award, a mark of quality under-pinning all necessary testing of the product materials, design and production techniques.

Beech (light)



Brown (dark)



FOOT OPTIONS:

Wood is a natural product and will vary in shade/colour from item to item. Feet may require fitting.

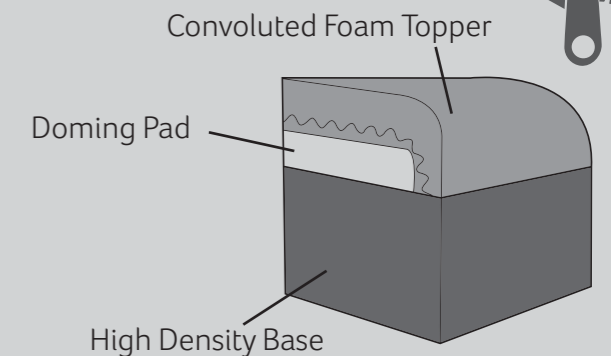

The mark of responsible forestry

10/09/2019